

## EPEE HOMMES EQUIPES

22.05.2011 - FONTAINE LE COMTE

## Tableau de de base

## Tableau 32 : 1/2

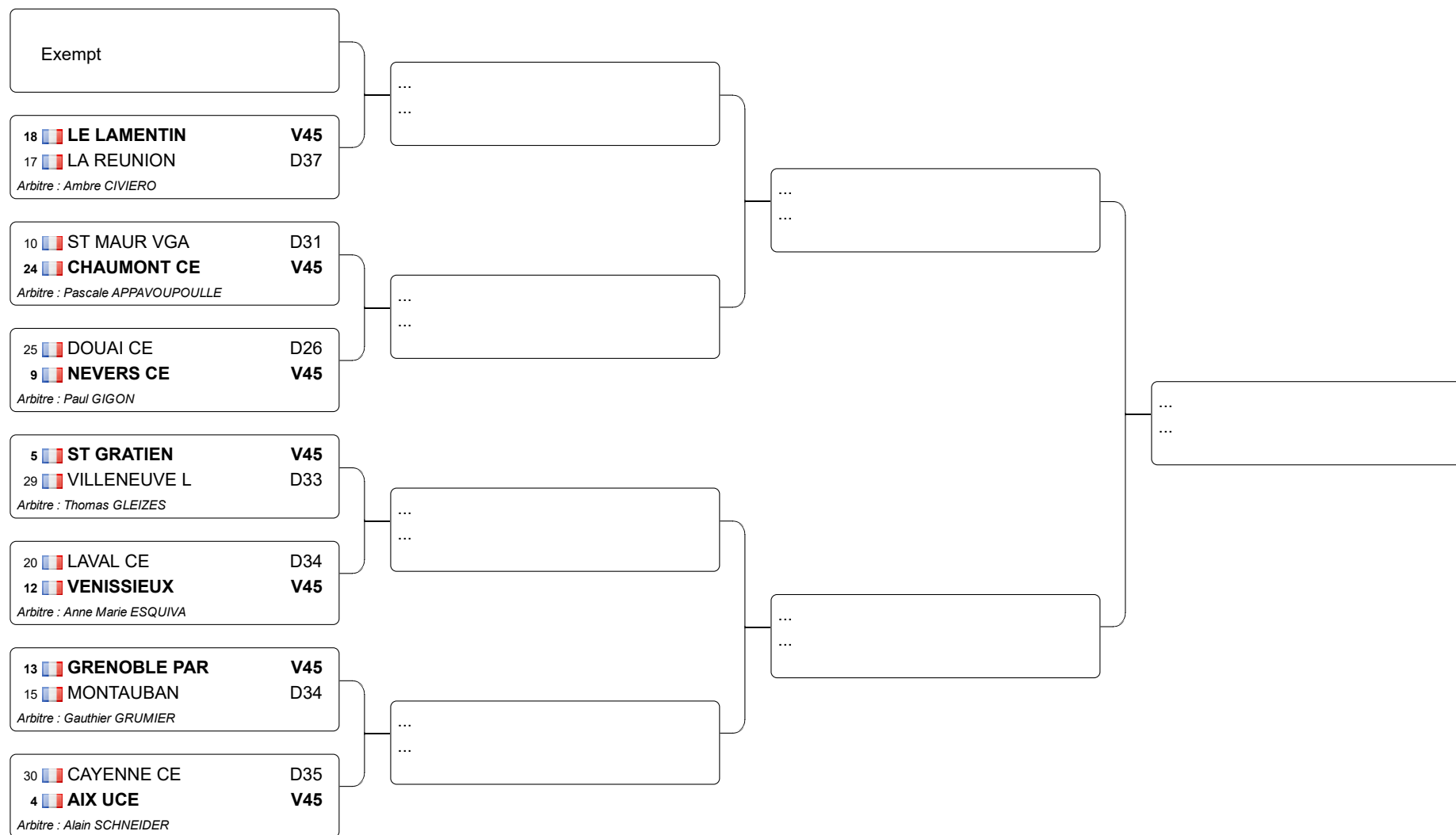

### Tableau 32 : 2/2

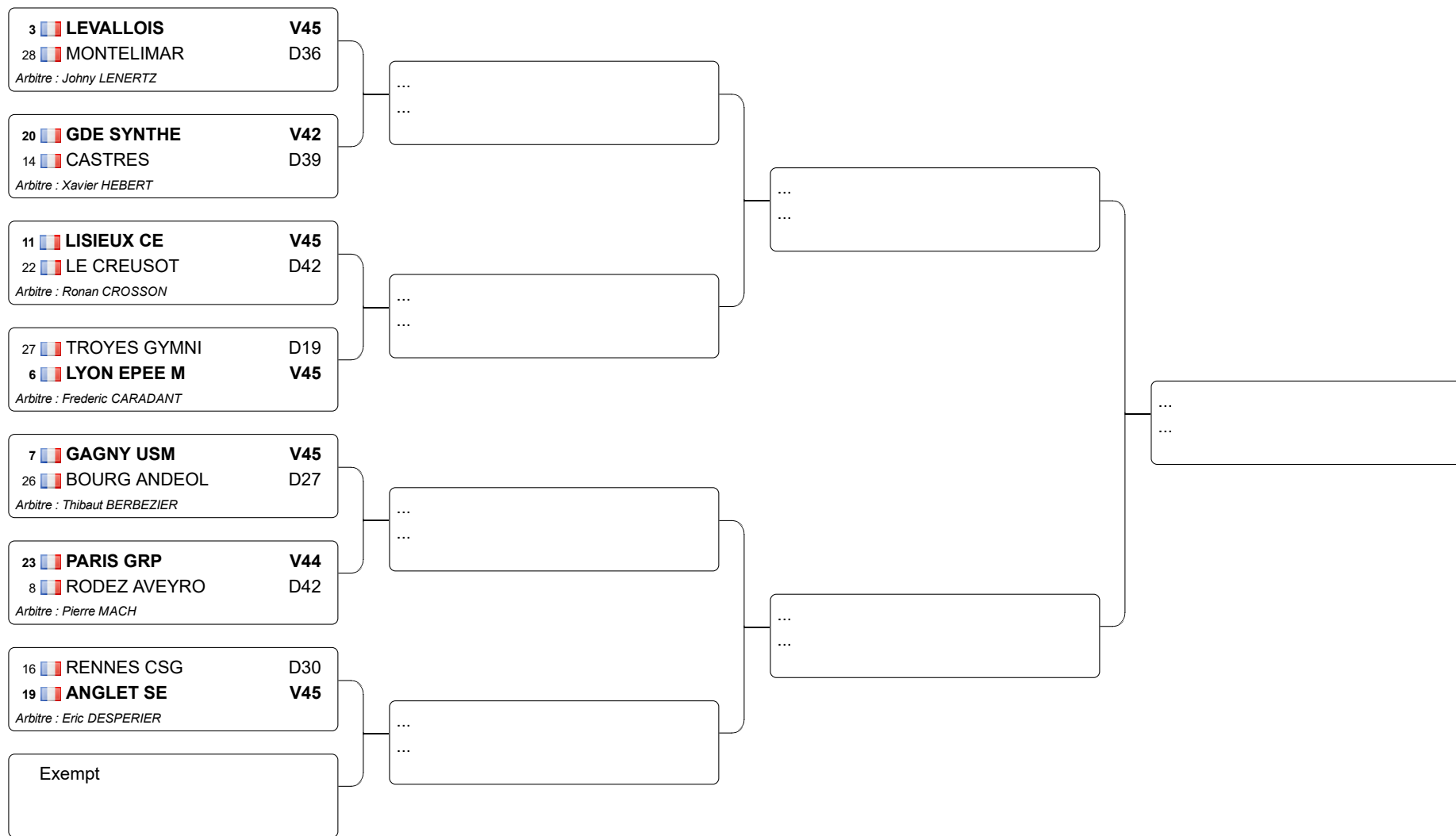

### Tableau 16

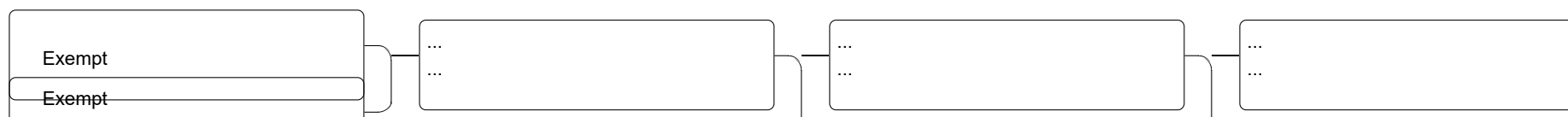

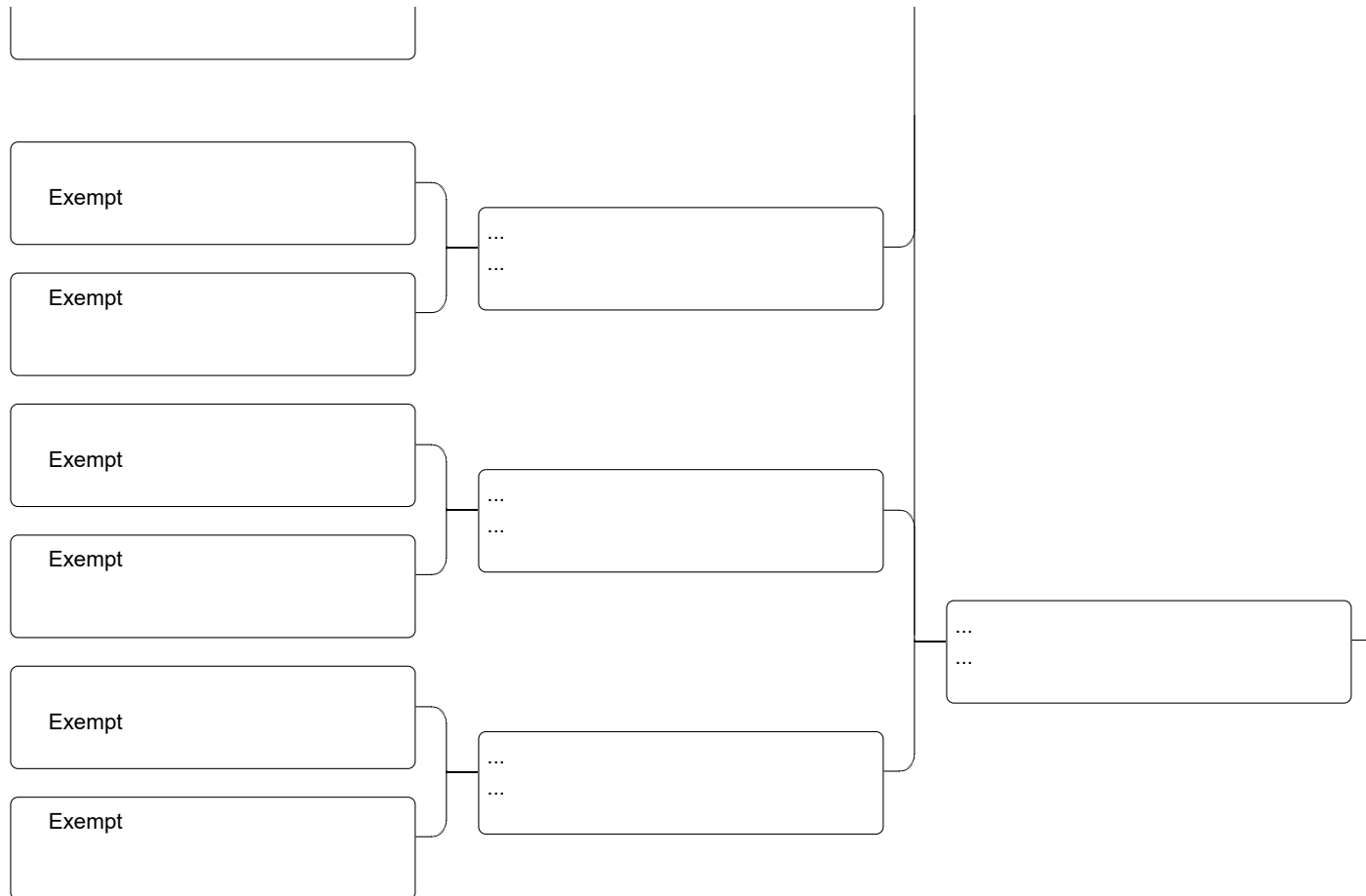

**Tableau a**

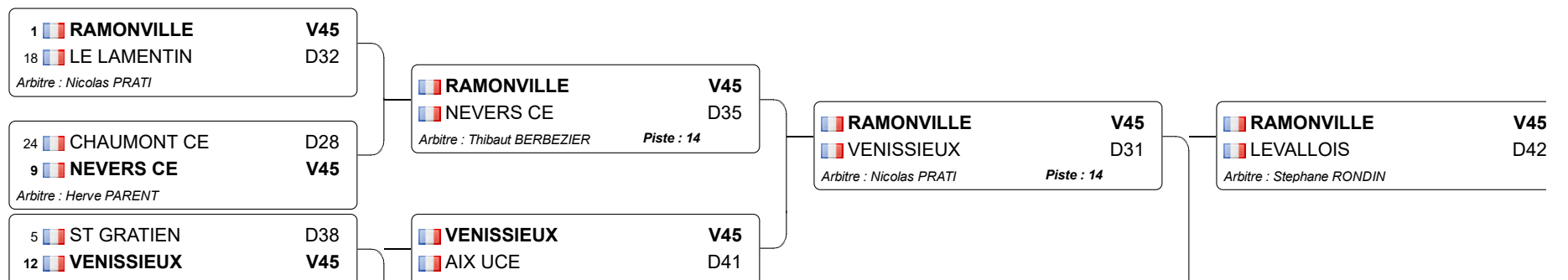



Tableau b



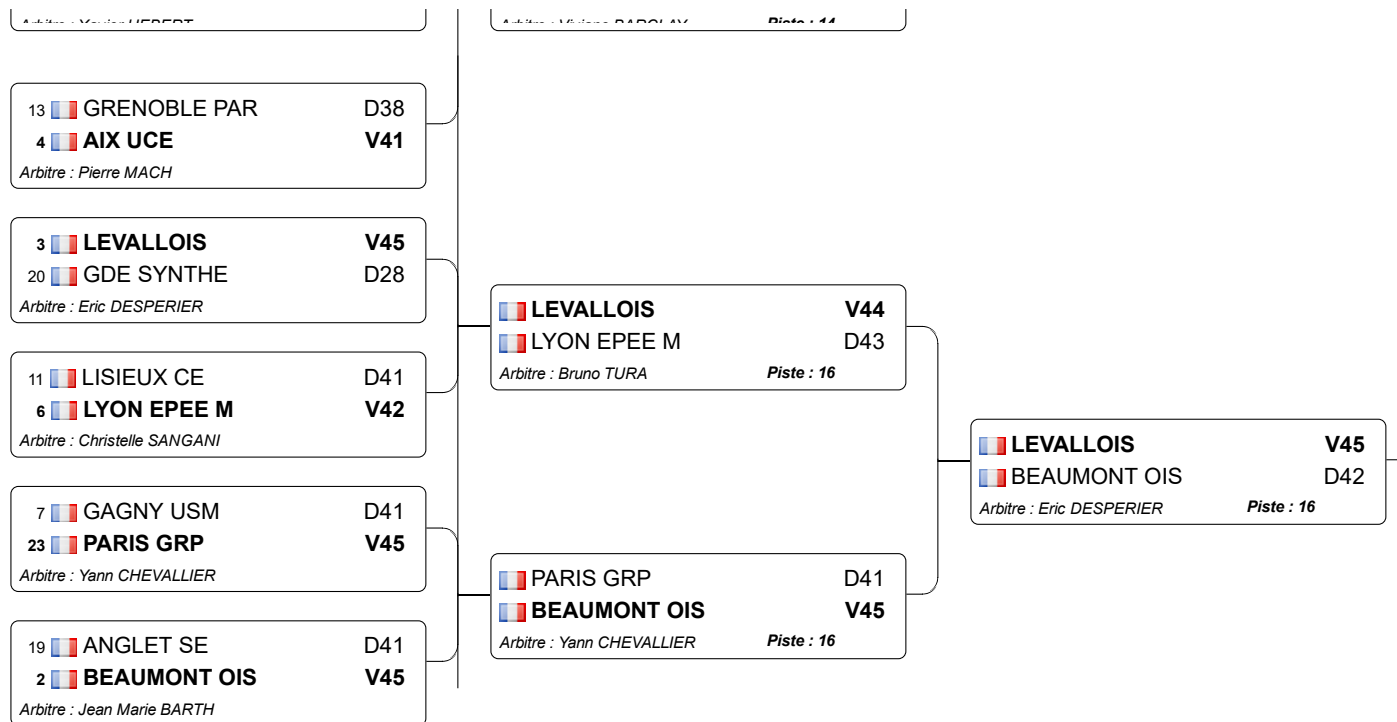
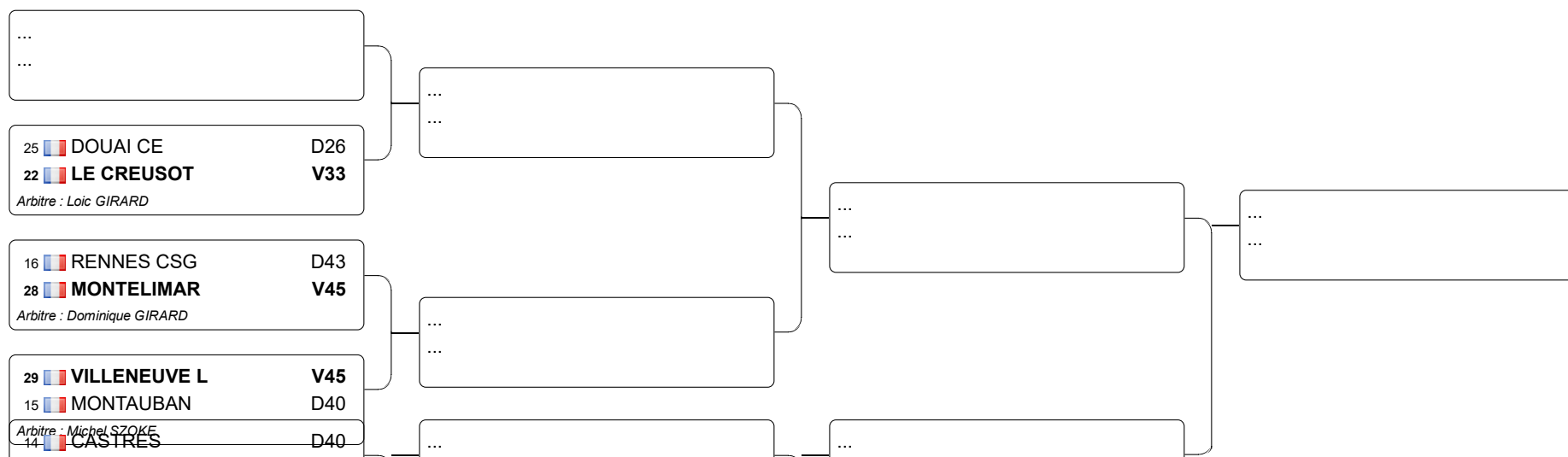
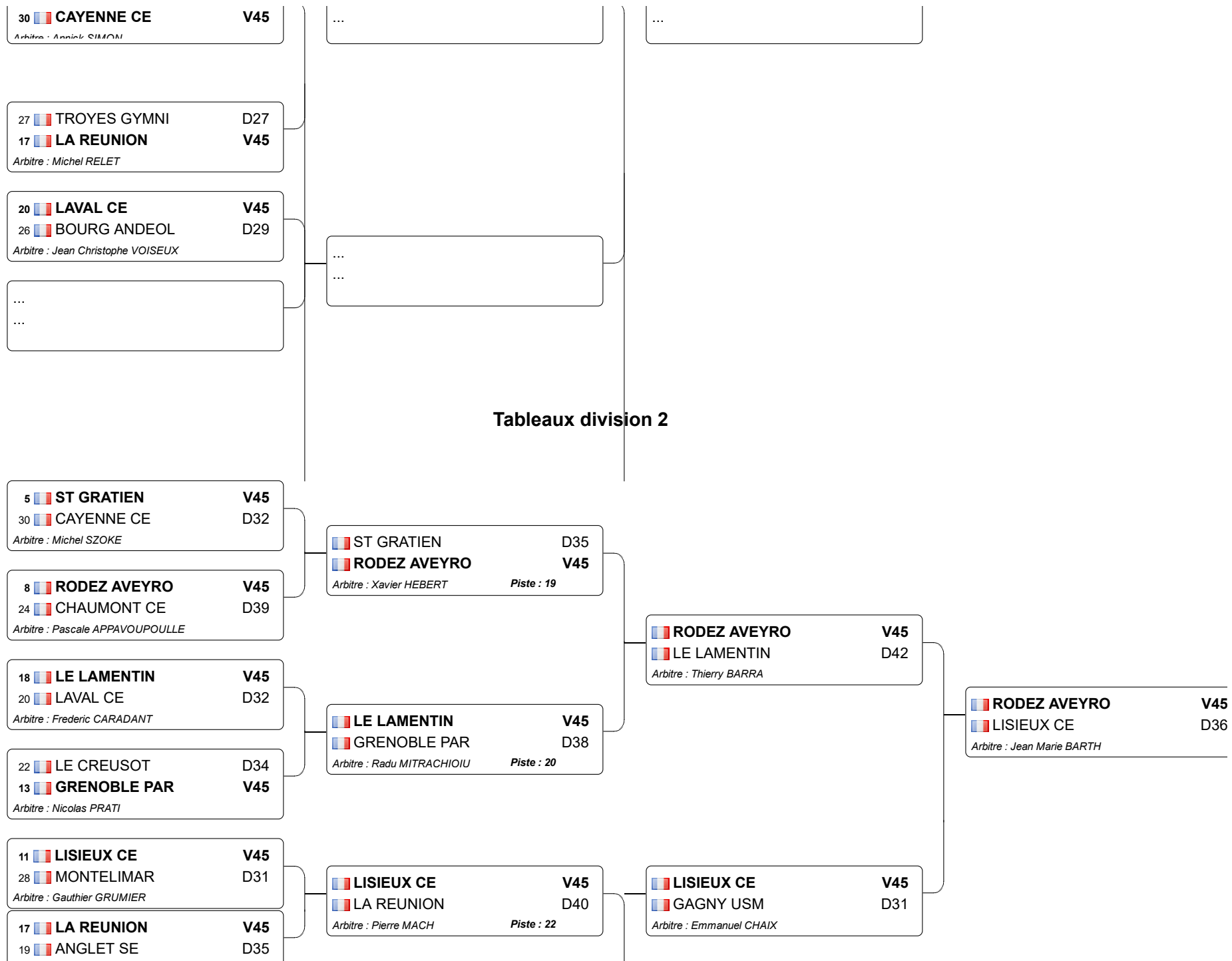

Arbitre : *Benoit CABRIE*

20		<b>GDE SYNTHE</b>	<b>V45</b>
10		<b>ST MAUR VGA</b>	<b>D35</b>
<i>Arbitre : Benoit JANVIER</i>			

29		<b>VILLENEUVE L</b>	<b>D27</b>
7		<b>GAGNY USM</b>	<b>V45</b>
<i>Arbitre : Michel RELET</i>			

	<b>GDE SYNTHE</b>	<b>D24</b>
	<b>GAGNY USM</b>	<b>V45</b>
<i>Arbitre : Michel SZOKE</i>		<i>Piste : 24</i>

### Tableaux division 1